

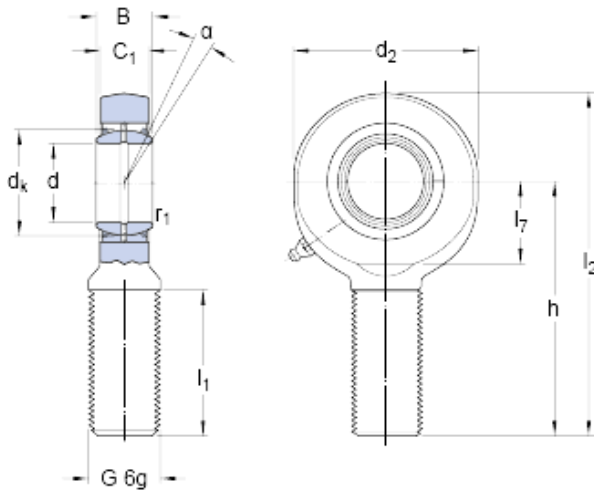

NTN Bearing Rolamentos do Brasil Ltda.



skf SAA 50 ES-2LS Spherical plain bearings and rod ends with a male thread

Bearing No. SAA 50 ES-2LS

d	50 mm
d ₂ max.	114 mm
B	35 mm
G	M 45x3
C ₁ max.	31 mm
h	185 mm
	6 °
d _k	66 mm
l ₁ min.	104 mm
l ₂ max.	244 mm
l ₇ min.	58 mm
r ₁ min.	0.6 mm
Basic dynamic load rating C	156 kN
Basic static load rating C ₀	245 kN
Specific dynamic load factor K	100 N/mm ²
Material constant K _M	330
Mass rod end	3.3 kg

SAA 50 ES-2LS Bearing 2D drawings and 3D CAD models